

SHERAZADE

Design Piero Lissoni



SHERAZADE SWING PLAIN PATCHWORK



SHERAZADE

Design Piero Lissoni

SHERAZADE SWING PLAIN PATCHWORK

Sherazade Swing Plain Patchwork è una porta singola a battente prodotta su misura, che si distingue per la grande pulizia formale, in cui il telaio dell'anta è a raso muro. Una porta dalla grande eleganza e cura dei dettagli, la cui superficie è ripartita in quattro riquadri, in cui possono essere posizionati diversi tipi di cristalli temperati monolitici mm. 6 o stratificati mm 3+3. Questi pannelli, tramite una guarnizione, vengono inseriti al centro di profili d'alluminio, forniti in cinque diverse finiture. I vetri, disponibili in una vastissima gamma di finiture, sono certificate secondo le normative di sicurezza ANSI Z97.1 e UNI ENI 2150 (ad eccezione di 533. retinato). Sono disponibili anche pannelli in gres o in legno, con diverse finiture ed essenze. È possibile montare tre tipi di serratura (senza blocco, con cilindro, con nottolino) e scegliere tra maniglia o pomolo, che sono forniti nella stessa finitura del telaio. Le cerniere sono a perno regolabili. Il controtelaio in alluminio decapato, invisibile quando la porta è chiusa, è disponibile sia per pareti cementizie sia in cartongesso e può essere verniciato direttamente con la pittura delle pareti. L'anta singola è disponibile anche nella versione filo soffitto. L'intero gruppo maniglia è trattato con una speciale vernice igienizzante (testata secondo la norma ISO 22196:2011) che, contrastando la proliferazione batterica, garantisce la massima igiene e pulizia delle superfici.

Sherazade Swing Plain Patchwork is a single custom made swing door with a concealed frame, which stands out for its clean lines, whose door panel fits flush to the wall. Is a door panel of great detail and elegance whose surface is divided into four parts where different types of glass, tempered monolithic 6 mm. or laminated 3+3 mm., can be used. These panels, fitted using a gasket, are inserted in the centre of the aluminum profiles, supplied in five different finishes. The glass, available in a very wide range of finishes, is certified in compliance with the ANSI Z97.1 and UNI ENI 2150 safety regulations (except the finish 533. retinato). Panels in stoneware and in wood with different finishes and essences are available too. It is possible to assemble three kinds of lock (without block, with cylinder; with revolving plug) and choose between handle or knob and they are supplied in the same finish of the frame. The hinges are with adjustable pivot. The pickled aluminium subframe, invisible when the door is closed, is available for both cement and plasterboard walls and it can be varnished during the painting of the walls. The single swing door is also available fitted flush to the ceiling. The entire handle set is treated with a special sanitizing varnish (tested according to ISO 22196: 2011) which, by counteracting bacterial overgrowth, guarantees maximum hygiene and cleanliness of the surfaces.

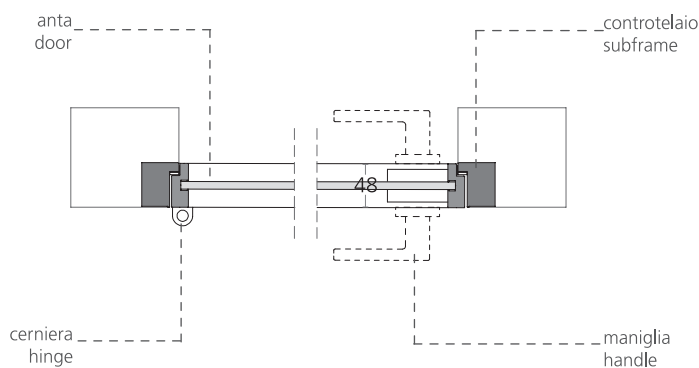
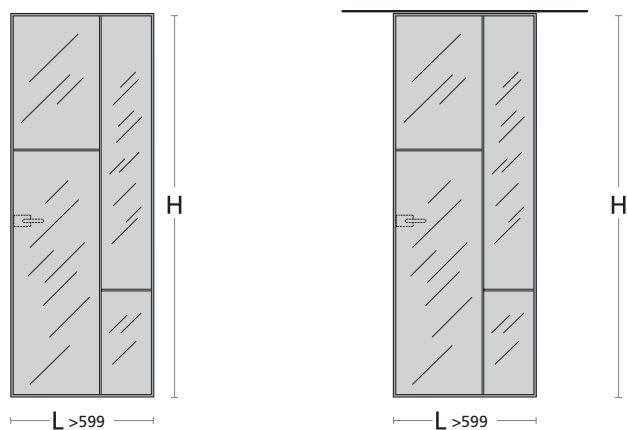

GLAS
ITALIA

Sede, direzione commerciale e showroom: Via Cavour 29 - 20846 Macherio (MB)
tel. +39 039.23 23 202 ra - fax +39 039.23 23 212 - e-mail: glas@glasitalia.com - www.glasitalia.com

SHERAZADE

Design Piero Lissoni

SHERAZADE SWING PLAIN PATCHWORK

CONFIGURAZIONE PORTA BATTENTE / CONFIGURATION SWING DOOR

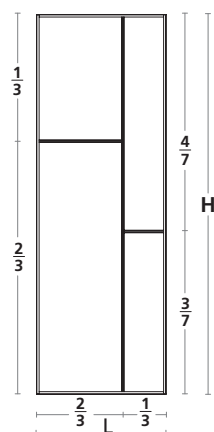

codice
code
SSWPP01

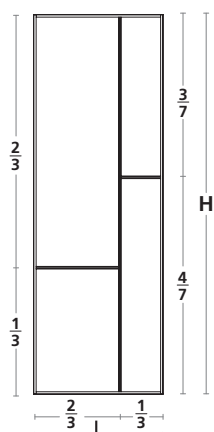

codice
code
SSWPP02

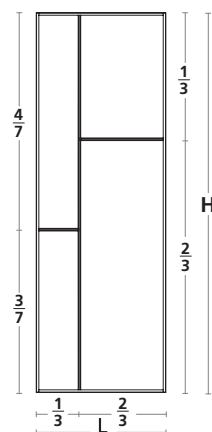

codice
code
SSWPP03

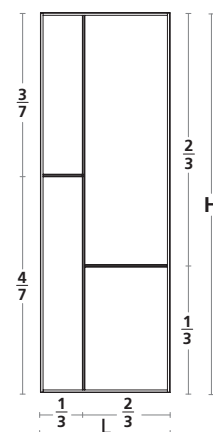

codice
code
SSWPP04

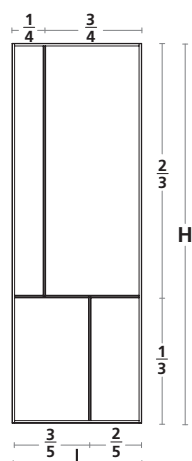

codice
code
SSWPP05

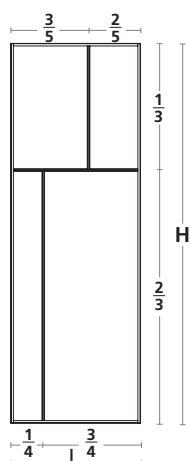

codice
code
SSWPP06

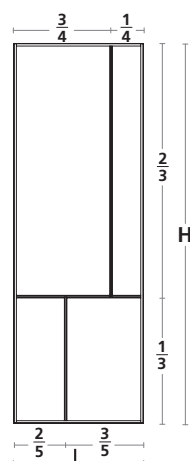

codice
code
SSWPP07

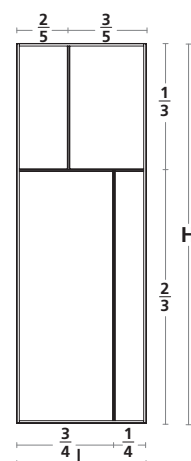

codice
code
SSWPP08

SHERAZADE

Design Piero Lissoni

SHERAZADE SWING PLAIN PATCHWORK

MANIGLIE PORTA BATTENTE / HANDLES SWING DOOR

Maniglia senza blocco /
Handle without block

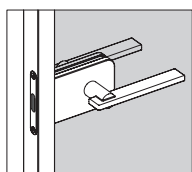

codice
code
LSSBA

Maniglia con cilindro /
Handle with cylinder lock

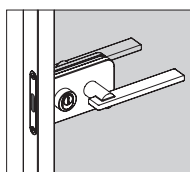

codice
code
LSCYA

Maniglia con nottolino A /
Handle with revolving plug A

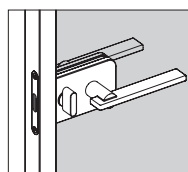

codice
code
LSCNA

Maniglia con nottolino B /
Handle with revolving plug B

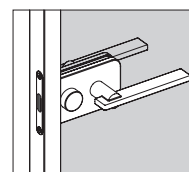

codice
code
LSCNNA

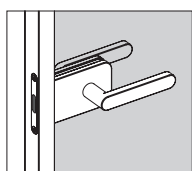

codice
code
LSSBB

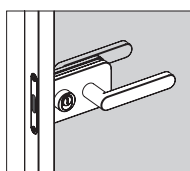

codice
code
LSCYB

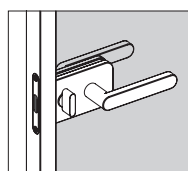

codice
code
LSCNB

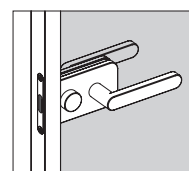

codice
code
LSCNNB

POMOLI PORTA BATTENTE / KNOBS SWING DOOR

Pomolo senza blocco /
Knob without block

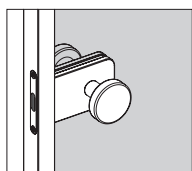

codice
code
PSSB

Pomolo con cilindro /
Knob with cylinder lock

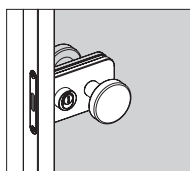

codice
code
PSCY

Pomolo con nottolino A /
Knob with revolving plug A

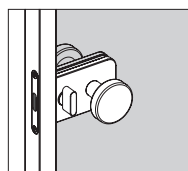

codice
code
PSCN

Pomolo con nottolino B /
Knob with revolving plug B

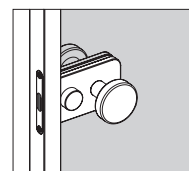

codice
code
PSCNN