

ALADIN

Design Piero Lissoni



ALADIN WALL



ALADIN

Design Piero Lissoni

ALADIN WALL MONO

Aladin Wall Mono è una parete divisoria, terra-soffitto, con un vetro stratificato mm. 5+5 (o mm. 4+6) applicato su un lato dei profili d'alluminio, fissati a pavimento, soffitto e parete, in modo da presentare una faccia con superficie planare e l'altra con superficie arretrata rispetto ai profili stessi.

La struttura d'alluminio, disponibile in cinque diverse finiture, prevede un sistema di regolazioni per mettere la parete in bolla e compensare le irregolarità degli ambienti. Nella parete sono integrabili tutti i modelli di porte a battente e scorrevoli Glas Italia, coordinate nelle stesse finiture o con finiture diverse. (Attenzione: non tutte le tipologie di vetro utilizzabili nella parete sono disponibili in ogni modello di porta). Il vetro, disponibile in una vastissima gamma di finiture, è certificato secondo le normative di sicurezza ANSI Z97.1 e UNI EN12150.

Sono disponibili anche pannelli in gres o in legno in diverse finiture ed essenze.

REGOLAZIONE DELLA PARETE:

- Soffitto 8 mm.
- Pavimento 12 mm.

Aladin Wall Mono is a wall partition, floor-ceiling, with laminated glass 5+5 mm. thick (or 4+6 mm. thick) applied on one side of the aluminum profiles, fixed to floor, ceiling and/or wall, so that one side has a flush surface and the other is rebated from the profiles themselves.

The aluminum structure, available in 5 different finishes, is supplied with an adjustment system to level the wall partition and to compensate irregularities in the floor or ceiling.

The wall partition can be integrated with all the Glas Italia models of swing and sliding doors, and in the same or different finishes. (Note: not all glass finishes usable for the wall partition is available with every door model).

The glass, available in a wide range of finishes, is certified in compliance with the safety regulation ANSI Z97.1 and UNI EN12150.

The panels are also available in stoneware or wood in many different finishes.

WALL ADJUSTMENT:

- CEILING 8 mm.
- FLOOR 12 mm.

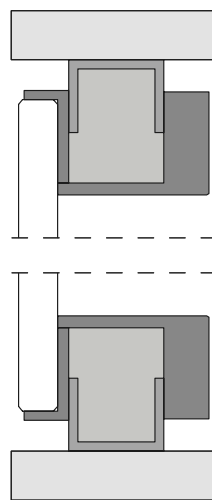
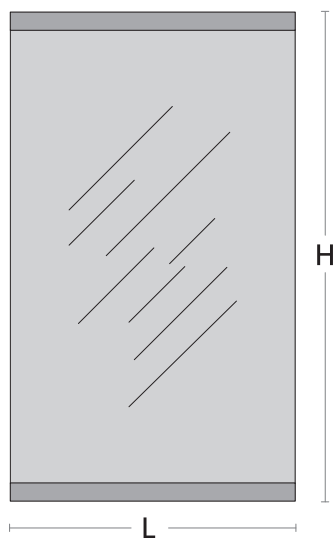

ALADIN

Design Piero Lissoni

ALADIN WALL DUO

Aladin Wall Duo è una parete divisoria, terra-soffitto, con doppio vetro stratificato mm. 5+5 (o mm. 4+6) applicato su entrambi i lati dei profili d'alluminio fissati a pavimento, soffitto e parete, in modo da formare una camera d'aria interna e avere superfici perfettamente planari sulle due facce della parete.

La struttura d'alluminio, disponibile in cinque diverse finiture, prevede un sistema di regolazioni per mettere la parete in bolla e compensare le irregolarità degli ambienti. Nella parete sono integrabili tutti i modelli di porte a battente e scorrevoli Glas Italia, coordinate nelle stesse finiture o con finiture diverse (attenzione, non tutte le tipologie di vetro utilizzabili nella parete sono disponibili in ogni modello di porta). Il vetro, disponibile in una vastissima gamma di finiture, è certificato secondo le normative di sicurezza ANSI Z97.1 e UNI EN12150.

Sono disponibili anche pannelli in gres o in legno in diverse finiture ed essenze.

REGOLAZIONE DELLA PARETE:

- Soffitto 8 mm.
- Pavimento 12 mm.

Aladin Wall Duo is a wall partition, floor-ceiling, with double laminated glass 5+5 mm. (or 4+6 mm.) applied on both sides of the aluminum profiles, fixed to floor, ceiling and wall, so as to form an internal air chamber and have surfaces perfectly flush on both sides of the wall.

The aluminum structure, available in 5 different finishes, is supplied with an adjustment system to level the wall and to compensate irregularities in the floor or ceiling.

The wall partition can be integrated with all the Glas Italia models of swing and sliding doors, and in the same or different finishes. (Note: not all glass finishes usable for the wall partition is available with every door model).

The glass, available in a wide range of finishes, is certified in compliance with the safety regulation ANSI Z97.1 and UNI EN12150.

The panels are also available in stoneware or wood in many different finishes.

WALL ADJUSTMENT:

- CEILING 8 mm.
- FLOOR 12 mm.

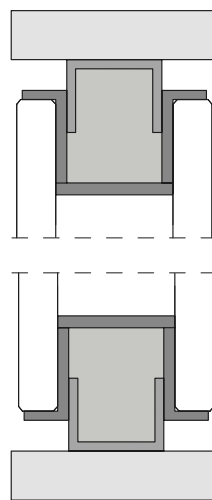
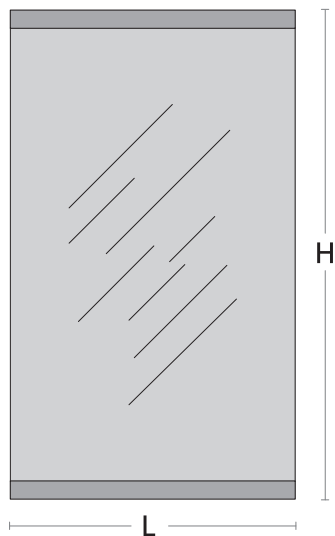

ALADIN

Design Piero Lissoni

ALADIN WALL MONO

ALADIN WALL DUO

ESEMPI CONFIGURAZIONE ALADIN WALL / ALADIN WALL EXAMPLE COMPOSITIONS

Configurazione parete lineare con porta battente /
Linear wall configuration with swing door

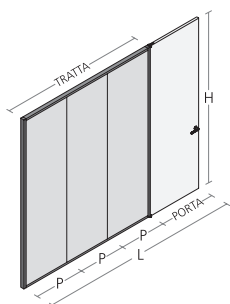

Configurazione parete angolare con porta scorrevole /
Angular composition with slide door

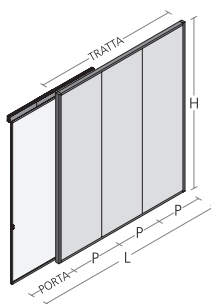

Configurazione parete lineare con porta battente /
Linear wall configuration with swing door

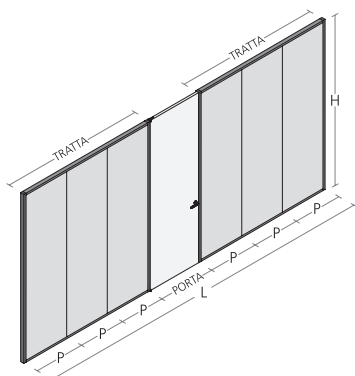

Configurazione penisola con porta scorrevole /
Peninsula wall composition with slide door

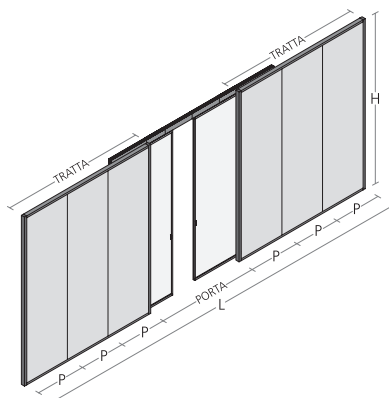

Configurazione parete con snodo 3 vie e porte battente /
Wall composition with 3 ways join and swing doors

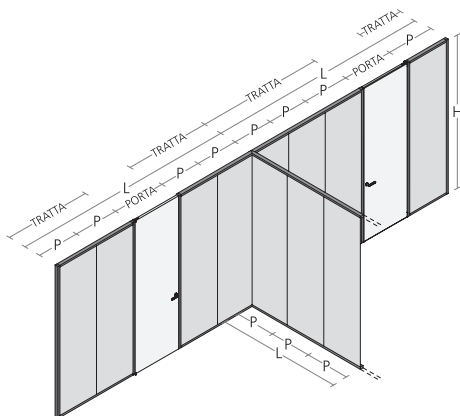

Configurazione isola con porta scorrevole /
Island free standing wall composition with slide door

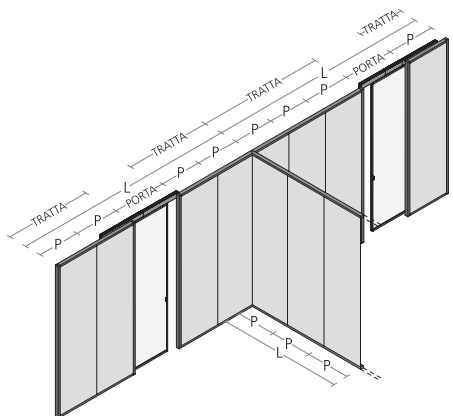

ALADIN

Design Piero Lissoni

ALADIN WALL MONO

ALADIN WALL DUO

ESEMPI CONFIGURAZIONE ALADIN WALL / ALADIN WALL EXAMPLE COMPOSITIONS

Configurazione parete angolare con porta battente /
Angular composition with swing door

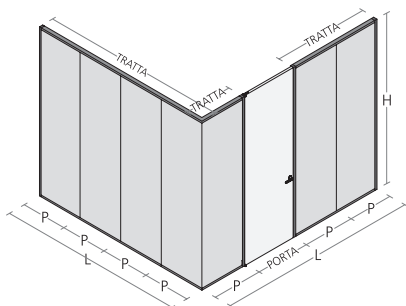

Configurazione parete angolare con porta scorrevole /
Angular composition with slide door

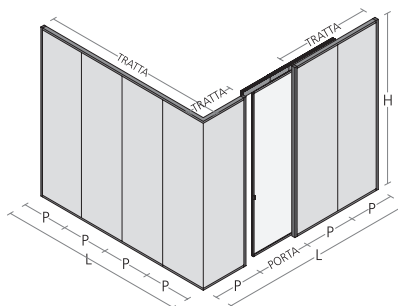

Configurazione penisola con porta battente /
Peninsula wall composition with swing door

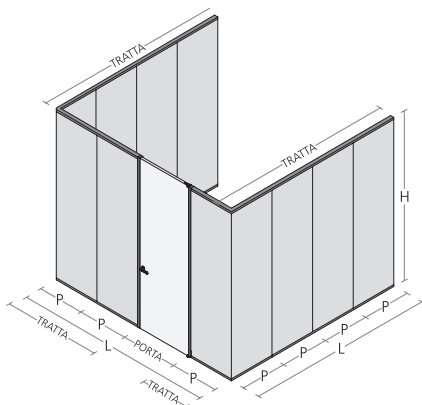

Configurazione penisola con porta scorrevole /
Peninsula wall composition with slide door

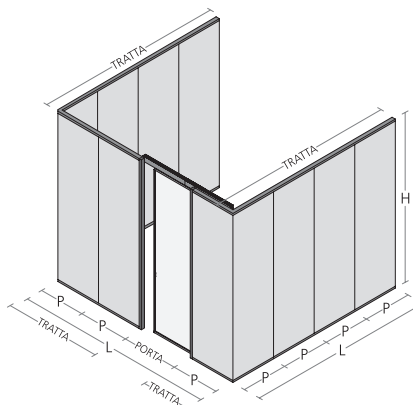

Configurazione isola con porta battente /
Island free standing wall composition with swing door

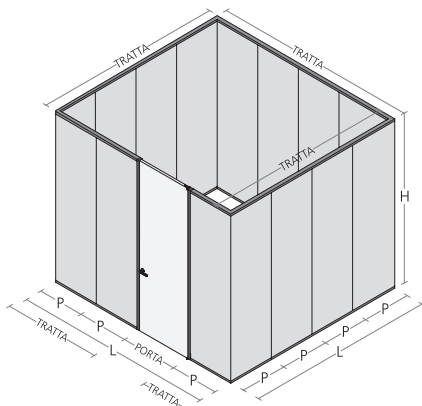

Configurazione isola con porta scorrevole /
Island free standing wall composition with slide door

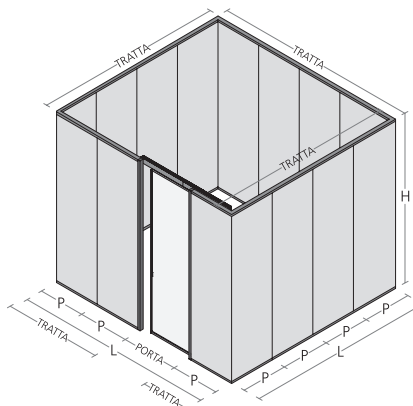

ALADIN

Design Piero Lissoni

ALADIN WALL MONO

ALADIN WALL DUO

MANIGLIE PORTA BATTENTE / HANDLES SWING DOOR

Maniglia senza blocco /
Handle without block

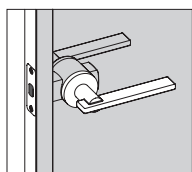

codice
code
LSBA

Maniglia con chiusura privacy /
Handle with privacy lock

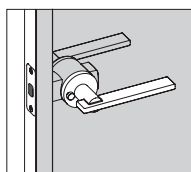

codice
code
LCPA

Maniglia con chiave /
Handle with key lock

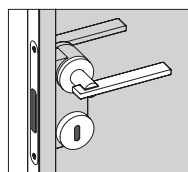

codice
code
LCCA

Maniglia con cilindro /
Handle with cylinder lock

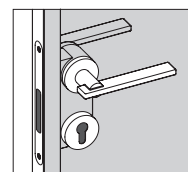

codice
code
LCYA

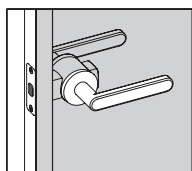

codice
code
LSBB

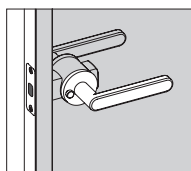

codice
code
LCPB

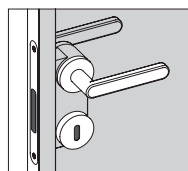

codice
code
LCCB

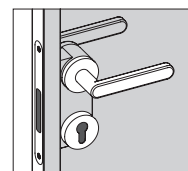

codice
code
LCYB

POMOLI PORTA BATTENTE / KNOBS SWING DOOR

Pomolo senza blocco /
Knob without block

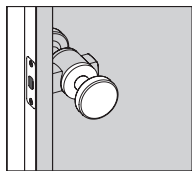

codice
code
PSB

Pomolo con chiusura privacy /
Knob with privacy lock

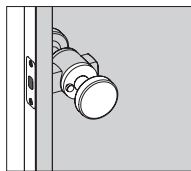

codice
code
PCP

Pomolo con chiave /
Knob with key lock

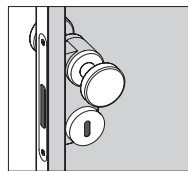

codice
code
PCC

Pomolo con cilindro /
Knob with cylinder lock

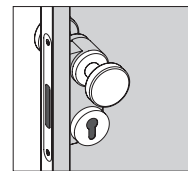

codice
code
PCY

ALADIN

Design Piero Lissoni

ALADIN WALL MONO

ALADIN WALL DUO

MANIGLIE PORTA SCORREVOLE / HANDLES SLIDE DOOR

Maniglia senza supporto /
Handle without support

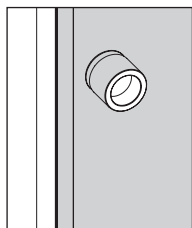

codice
code
MSS

Maniglia ovale senza supporto /
Oval handle without support

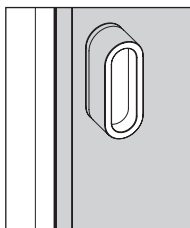

codice
code
MSO

Maniglia con supporto /
Handle with support

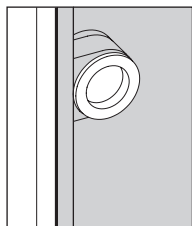

codice
code
MCS

Maniglia con chiave /
Handle with key lock

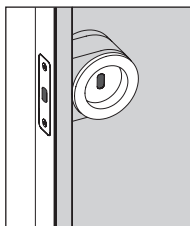

codice
code
MCC

Maniglia con nottolino /
Handle with revolving plug

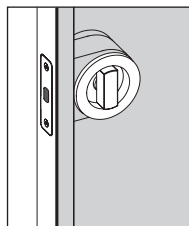

codice
code
MCN