

SHERAZADE

Design Piero Lissoni



SHERAZADE DOUBLE SWING FRAME



SHERAZADE

Design Piero Lissoni

SHERAZADE DOUBLE SWING FRAME

Sherazade Double Swing Frame è una porta doppia a battente prodotta su misura, che si distingue per la grande pulizia formale e la cura dei dettagli, con stipite telescopico e cerniere a perno regolabili. Un vetro temperato monolitico da 6 mm o stratificato da 3+3 mm è inserito tramite guarnizione in un telaio d'alluminio, fornito in cinque diverse finiture.

I vetri, disponibili in una vastissima gamma di finiture, sono certificati secondo le normative di sicurezza ANSI Z97.1 e UNI ENI 2150 (ad eccezione di 533, armato). Sono disponibili anche pannelli in gres o in legno, con diverse finiture ed essenze. È possibile montare tre tipi di serratura (senza blocco, con cilindro, con nottolino) e scegliere tra maniglia o pomolo che, come lo stipite, sono forniti nella stessa finitura del telaio.

Sherazade Double Swing Frame is a double custom made swing door with a telescopic jamb and adjustable pivot hinges, which stands out for its clean lines and attention to detail.

The monolithic 6 mm. or laminated 3+3 mm. thick tempered glass is inserted by means of a seal in the aluminum frame, which is supplied in five different finishes.

The glasses are available in a wide range of finishes and they are certified according to the safety regulations ANSI Z97.1 and UNI ENI 2150 (with the exception of 533, armato).

Panels in stoneware and in wood with different finishes and essences are available too.

It is possible to assemble three kinds of lock (without block, with cylinder, with revolving plug) and choose between handle or knob and, like the jamb, they are supplied in the same finish of the frame.

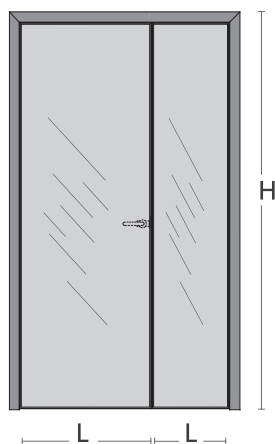

codice
code
SSWF2

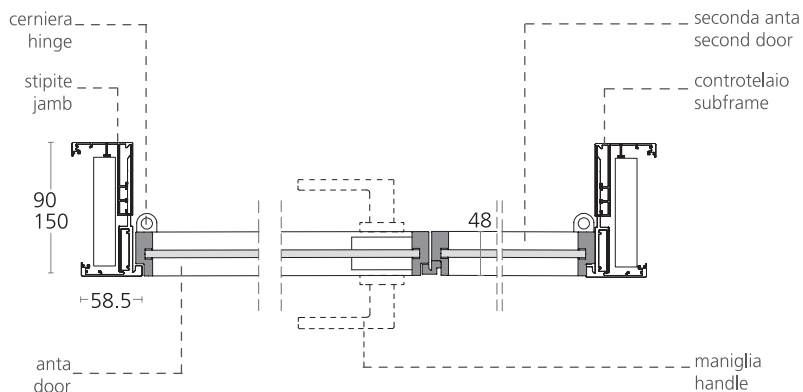

SHERAZADE

Design Piero Lissoni

SHERAZADE DOUBLE SWING FRAME

MANIGLIE PORTA DOPPIO BATTENTE / HANDLES DOUBLE SWING DOOR

Maniglia senza blocco /
Handle without block

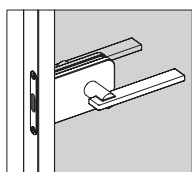

codice
code
LSSBA

Maniglia con cilindro /
Handle with cylinder lock

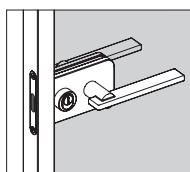

codice
code
LSCYA

Maniglia con nottolino A /
Handle with revolving plug A

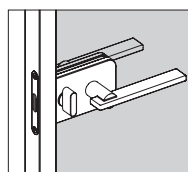

codice
code
LSCNA

Maniglia con nottolino B /
Handle with revolving plug B

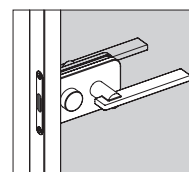

codice
code
LSCNNA

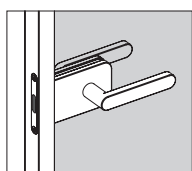

codice
code
LSSBB

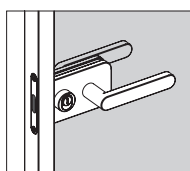

codice
code
LSCYB

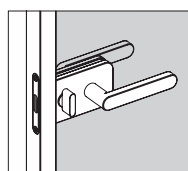

codice
code
LSCNB

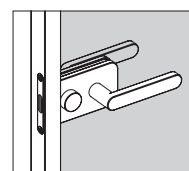

codice
code
LSCNNB

POMOLI PORTA DOPPIO BATTENTE / KNOBS DOUBLE SWING DOOR

Pomolo senza blocco /
Knob without block

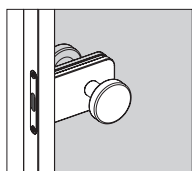

codice
code
PSSB

Pomolo con cilindro /
Knob with cylinder lock

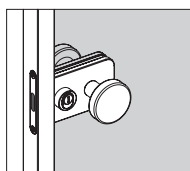

codice
code
PSCY

Pomolo con nottolino A /
Knob with revolving plug A

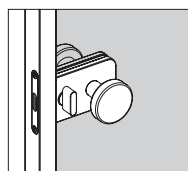

codice
code
PSCN

Pomolo con nottolino B /
Knob with revolving plug B

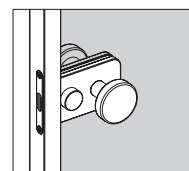

codice
code
PSCNN